

# DP-407.1 DIAPHRAGM PUMP

## Parts & Instruction Manual



Price \$10.00

### **CDS-JOHN BLUE COMPANY**

DIVISION OF ADVANCED SYSTEMS TECHNOLOGY, INC.

165 Electronics Blvd., Huntsville, Alabama 35824

Telephone: (256) 721-9090 • FAX (256) 721-9091 • Call Toll Free: 1-800-253-2583

## Table of Contents

NOTES TO THE OWNER.....	3
SELECTION OF PUMP AND EQUIPMENT DESIGN.....	3
SAFETY PRECAUTIONS.....	3-4
WARNING .....	4
INSTALLATION SCHEME.....	5
ORDINARY MAINTENANCE FOR DIAPHRAGM PUMPS.....	6-7
ORIGINAL SPARE PARTS.....	8
PRESSURE REGULATOR OPERATING INSTRUCTIONS.....	9
CHEMICAL RESISTANCE CHART.....	9
PARTS LIST AND DRAWINGS.....	10-11
TROUBLES AND CURES REFERENCE CHART.....	BACK COVER
WARRANTY.....	BACK COVER

### DP-407.1 PUMP DIMENSIONS

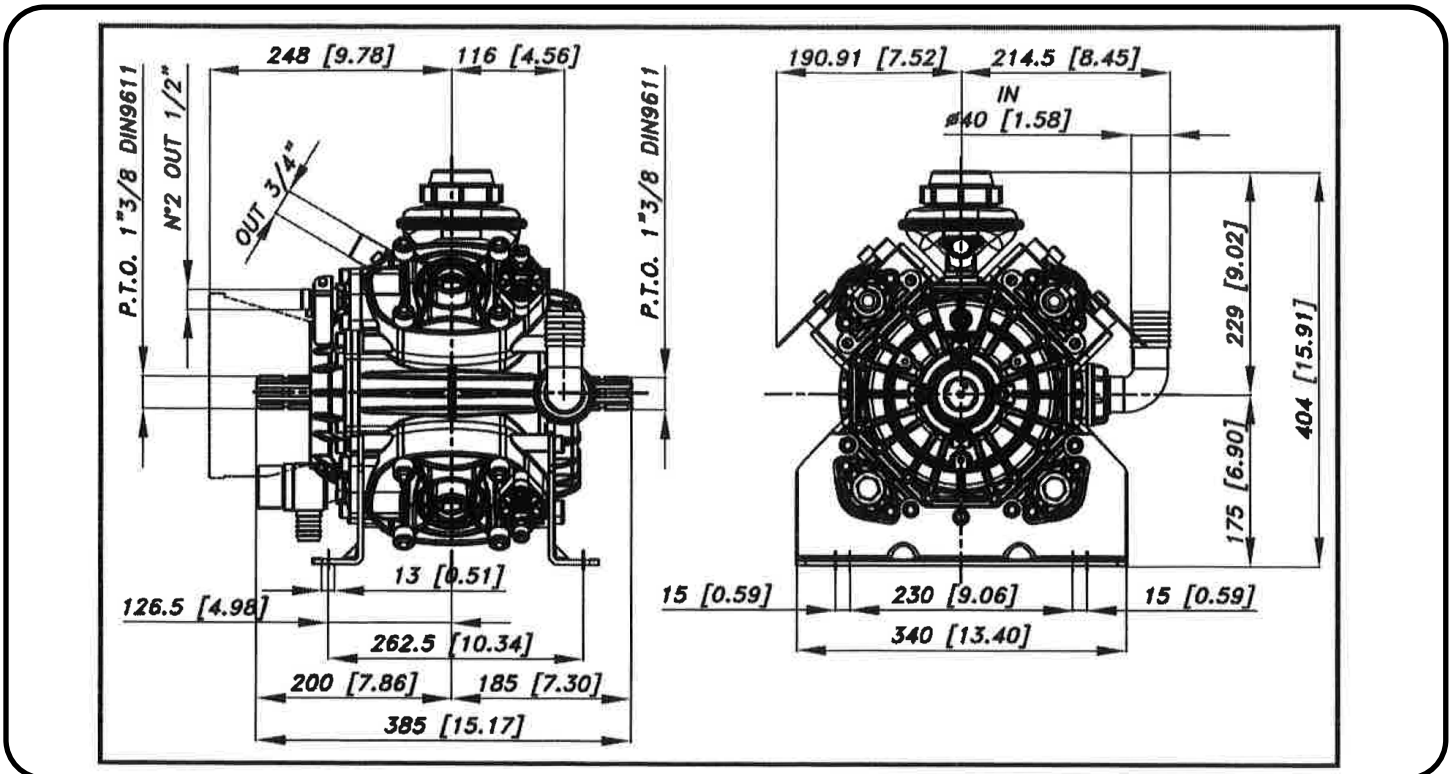

## NOTES TO THE OWNER

Thank you for purchasing a CDS-John Blue diaphragm pump. These pumps are equipped with mechanical diaphragms. They are manufactured with materials that make them suitable for weed control, liquid fertilizer, spraying and washing. A complete system with accessories is easily adapted to tractors, sprayers and boom sprayers, electric motors and gasoline/diesel engines.

This manual has been prepared and illustrated to assist you in the maintenance of your CDS-John Blue Diaphragm Pump. Enter your serial number and date of purchase for the diaphragm pump in the space provided below for ordering parts and service information.

Because our engineering department is constantly improving products, we reserve the right to make design and specification changes without notice.

Serial No. \_\_\_\_\_ Purchase Date \_\_\_\_\_

## SELECTION OF PUMP AND EQUIPMENT DESIGN

With regard to safety, all pumps meet the regulations in effect at publishing time. Choose the pump type carefully, according to the kind of liquid used and to the technical specifications (output, pressure) needed. If there are any questions about which pump type should be used, please contact our Technical Department.

CDS-John Blue diaphragm pumps are designed and manufactured with materials that are compatible with water. They are also compatible with most pesticides and herbicides currently on the market in the concentration recommended by the manufacturer. Use only pump liquid that is compatible with the pump component materials. Failure to follow this warning can result in injury and/or property damage.

The technical specifications of each pump (RPM, output, pressure) are shown on the label attached to the pump. For more information, refer to our Technical Department at 1-800-253-2583.

Carefully evaluate which pump model series to use. Using the correct pump type and size for the operation system can prevent possible bodily injury. Also use similar care when selecting the electric, gasoline/diesel motors or driven systems so they conform to the recommended performance to prevent personal injury and environment damage. Finally, it is important to be cautious during the design and construction of the equipment to prevent bodily injury, coming not from the pump, but from the design, construction or improper use of equipment.

A certified electrician should be used when wiring an electrically driven pump.

## SAFETY PRECAUTIONS

### GENERAL

- Do not operate equipment until you read and understand Operators Manual.
- Carry a first aid kit and five (5) gallons of clean water to flush contaminated skin and eyes.
- Agricultural chemicals can be dangerous. Improper selection or application can injure persons, animals, plants, soils or other property. Follow label from chemical manufacturer.
- Always wear eye protection and protective clothing when in the area of spray pump and/or control.
- In addition to the pressure regulator, use the proper safety relief valve in the plumbing after the pump.
- Before each use, make certain that all connections are tight and secure.
- Disconnect power before servicing.
- Do not pump flammable or combustible fluids.

- Do not operate pump above recommended rpm.
- Provide adequate protection in guarding around the moving parts such as the shaft and the pulley.
- Stop pump and release all pressure within the system before servicing any component.
- Do not operate pump above 145°F (62°C) liquid temperature.
- Do not remove the pressure dampener until air pressure has been completely vented.

**WARNING:** Severe Bodily injury may occur if the above precautions are not taken.

**WARNING:** USE OF THIS PRODUCT FOR ANY PURPOSES OTHER THAN ITS ORIGINAL INTENT, ABUSE OF THE PRODUCT, AND/OR MODIFICATION TO THE ORIGINAL PRODUCT IS STRICTLY PROHIBITED BY CDS-JOHN BLUE COMPANY. CDS-JOHN BLUE COMPANY RESERVES THE RIGHT TO DENY WARRANTY OR LIABILITY CLAIMS IN ANY/ALL SITUATIONS INVOLVING MISUSE, ABUSE OR MODIFICATION.

THE ORIGINAL INTENT OF THIS PRODUCT DOES NOT INCLUDE USE WHERE THE MAXIMUM ALLOWED SPEED, PRESSURE, OR TEMPERATURE IS EXCEEDED, AND IT DOES NOT INCLUDE APPLICATION UTILIZING FLUIDS THAT ARE NOT COMPATIBLE WITH THE PRODUCT'S COMPONENT MATERIALS. DO NOT USE THIS PRODUCT WITH FLAMMABLE OR COMBUSTIBLE FLUIDS SUCH AS GASOLINE, KEROSENE, DIESEL, ETC...., AND DO NOT USE IN EXPLOSIVE ATMOSPHERES. FAILURE TO FOLLOW THIS NOTICE MAY RESULT IN SERIOUS INJURY AND/OR PROPERTY DAMAGE AND WILL VOID THE PRODUCT WARRANTY. IF IN DOUBT ABOUT YOUR APPLICATION, CONTACT YOUR STOCKING DEALER OR THE CDS-JOHN BLUE TECHNICAL STAFF AT 1-800-253-2583.

## OPERATIONAL

- Equipment should be operated only by trained, responsible people.
- Do not allow anyone but operator on equipment.
- Wear safety goggles and/or respirator when operating applicator.
- Do not attempt any service or disassembly without **stopping machine** and releasing all pressure from system.
- Do not operate equipment with shields removed.
- Make a visual inspection of all hose and fittings for soundness on a scheduled basis.
- Replace anything which appears questionable.

## INSTALLATION

1. Pump should be installed perfectly lined up with the driven gears (pulleys, gear boxes, overgears, etc.).
2. Attach the pump to a strong base plate and anchor it with bolts sufficiently strong enough to hold it in place.
3. Proper selection of type and hose size is vital to good performance:
  - Diameter of suction, discharge and by-pass hoses should be at least that of the pump hose barb or greater.
  - Use only hoses rated for maximum pressure rating of the pump.
4. Use suction line of spiral steel wire braid reinforced suction hose to prevent collapse. Use good quality hose clamps and tighten securely.
5. Use only components (hose, fittings, clamps, etc.) rated for maximum pressure rating of the pump.
6. Failure to follow the above information can result in malfunctions of the pump and will void the product warranty.

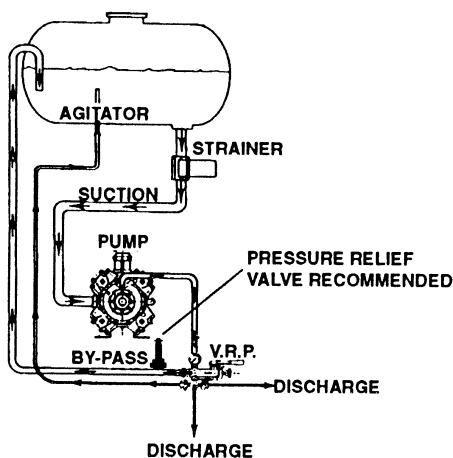

# INSTALLATION SCHEME

## CHECKS TO MAKE BEFORE USING THE PUMP

- With the pump not running, check to make sure that the oil level is correct. Add oil, if needed, taking care not to exceed the indicated level. Repeat with pump running. See "Oil Change" on page 7.

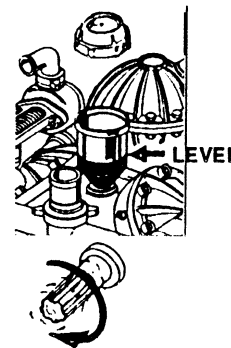
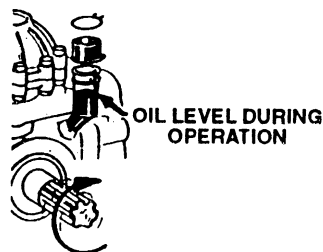
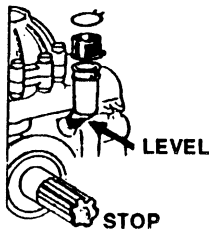

- Check to make sure the inlet and discharge hoses are not crimped. Also make sure the strainer is clean.
- Prevent any hose restrictions and be sure connections are tight to prevent air entering, since these conditions will compromise pump performance.
- If pumping from a tank, check to make sure that the control unit by-pass line is not too close to the inlet line. Make sure that it does not create turbulence inside the tank.
- Turn the pressure adjustment lever to the by-pass position when starting the pump.
- The pulsation dampener on the pump or on the pressure line is generally charged at 80-120 psi, the recommended pressure rating for the pump.
- For different working pressures, set the pressure of the pulsation dampener as follows:

### WORKING PRESSURE

300 - 700 psi  
150 - 300 psi  
70 - 150 psi

### PULSATION DAMPENER PRESSURE

80 - 120 psi  
70 - 80 psi  
15 - 70 psi

**Note:** As a general rule, set the pulsation dampener to 1/3 the working pressure without exceeding 100 psi. Also, with the pump not running, check the pressure with a pressure gauge. It is a good practice to inspect the pulsation dampener diaphragm at regular intervals.

## SUCTION HEAD

Do not use pump for filling the tank. The hydroinjector, with a proper nozzle, can be used for this purpose. Avoid suction head higher than approximately 10 ft. and use the correct length for hoses, without elbow runs, better if pre-charged. In this case some problems may occur with the pump diaphragms.

## OPERATING INSTRUCTIONS

- When starting pump, turn the valve lever to the dump position (by-pass) to facilitate priming. Once the pump is primed, turn the valve lever to the "PRESS" position and adjust the working pressure with the knob: turning knob clockwise will increase pressure, turning knob counterclockwise will decrease pressure.
- Operating pump above recommended rpm will not improve performance, but may damage the pump. Operation at rpm higher than specification voids all warranties.
- Be sure that the oil level is not above the maximum level with the pump running with pressure.

## AFTER USE

After use, in order to prevent damage, flush pump and let operate for a few minutes at working pressure with a solution that will neutralize the liquid last pumped (refer to that manufacturer's instructions). Afterward empty the pump, so that the pressure drops to zero ("0"), and then let the pump run without liquids for two minutes.

**To protect pump from freezing**, flush pump per instructions above (after use) and then flush with straight RV-antifreeze. Empty the pump per the instructions above.

Periodically (at the end of a season) inspect the pump and the system components (hoses, connections and so on) and replace necessary parts.

## **ORDINARY MAINTENANCE FOR DIAPHRAGM PUMPS**

Routine maintenance on the pump includes changing the diaphragms, oil, valve assembly and o-rings, all of which are normal wear parts.

### VALVE ASSEMBLY AND O-RING REPLACEMENT

Occasionally, debris can cause the valves to not seat properly or damage o-rings. To check for this problem please follow these steps:

1. Remove the valve cover (or the manifold) and remove the valves, check for debris and wear. Also check o-rings.
2. Replace necessary parts and reassemble.
3. Repeat for all valves. Consult the parts list for the corresponding valve kit or o-ring kit part number.

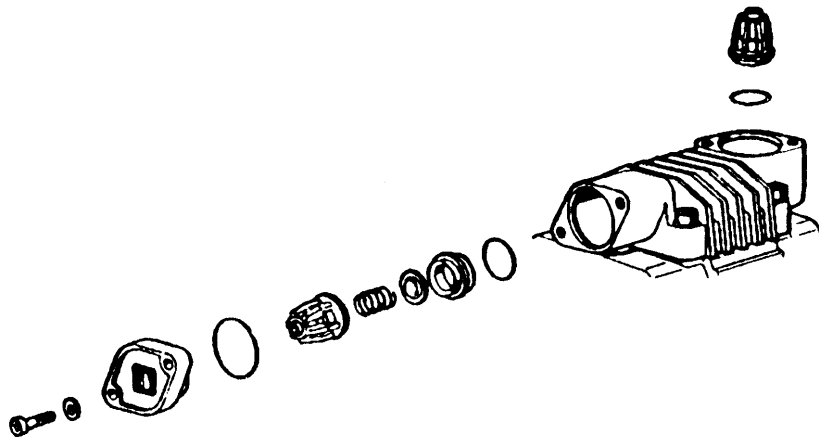

## DIAPHRAGM REPLACEMENT

1. Remove the pump heads one by one.
2. Use a wrench to remove the diaphragm bolt, diaphragm and support washer.
3. If you removed the piston sleeves, replace them one at a time in their previous position. It is a good idea to mark them as they are removed.
4. Insert the new diaphragm on the piston and install it with its bolt. Use these tightening torques:

			<b>Diaphragm Bolt Size</b>	<b>Torque</b>
M 6 x 1	=	5 N.m.	6 mm	44 inch-pounds
M 8 x 1,25	=	12 N.m.	8 mm	106 inch-pounds
M 10 x 1,25	=	25 N.m.	10 mm	221 inch-pounds

The diaphragms should be replaced with the piston at its bottom and the edges inserted perfectly into the groove all the way around.

5. Replace the heads and attach them with their bolts.
6. Refill pump with oil through the reservoir and rotate the shaft to distribute oil and fill to proper level. Repeat all the checks described above in the section "Checks to make before using the pump."
7. Check the oil level with the pump running and without pressure until all air bubbles have been vented. Close the cap on the oil sight tube after the air has been completely emptied.
8. After the first inspection of the oil level as above, check the oil level again with the pump running with pressure.

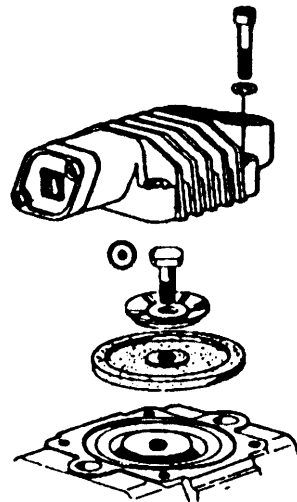

## OIL CHANGE:

Change oil after 500 hours as follows:

1. Remove the tank plug and the drain plug.
2. Rotate the shaft until the oil stops flowing.
3. Wash inside parts with diesel oil.
4. Put the drain plug and pour oil (SAE 30) slowly into sight tube while turning the pump shaft.
5. Start the pump at zero ("0") pressure for a few minutes to allow the correct lubrication of inside parts.
6. While the pump is operating, check the oil level inside the reservoir.
7. If necessary, fill oil to proper level.

**WARNING:** Too much oil causes pressure into the crankcase and this can result in leakage or diaphragm failures.

For pumps without the drain plug, it is not necessary to periodically change the oil. However, the oil should be changed when replacing diaphragms.

## COUPLING TO AGRICULTURAL MACHINERY

1. Check that the PTO of the machine does not exceed the maximum rpm shown on the pump plate.
2. Synchronized the PTO with the motor speed, consult the service manual to get the gear number and rpm corresponding to the maximum pump rotation speed.
3. When the rpm of the PTO is higher than the maximum speed, use the suggested reduction gear.
4. Disconnect PTO when moving pump out of service. If that is impossible, then disengagement should be provided.

## COUPLING TO ELECTRIC MOTORS AND GASOLINE ENGINES

For direct coupling always use the suggested reduction gear.

For coupling with pulley, check alignment of the two pulleys.

$$\text{Maximum Transmission Ratio} \frac{\text{Motor RPM}}{\text{Max Pump RPM}} = K$$

After determining K, you can establish the motor or pump pulley diameter:

$$\text{Motor Pulley Pitch Diameter} = \frac{\text{Pump Pulley Pitch Diameter}}{\text{Pump RPM}} = K$$

$$\text{Pump Pulley Pitch Diameter} = \text{Motor Pulley Pitch Diameter} \times K$$

**WARNING:** All wiring should be done by a qualified electrician.

**WARNING:** Do not handle a pump or pump motor with wet hands or when standing on a wet damp surface, or in water.

**For special installation or application consult our Technical Department for the necessary modifications.**

## **ORIGINAL SPARE PARTS**

Only use original spare parts, otherwise warranty will be declined.

Always enter the serial number printed on the pump label.

When ordering parts, please specify the following:

- pump model
- part number
- description
- quantity
- means of shipment



# PRESSURE REGULATOR OPERATING INSTRUCTIONS

Before starting, turn the valve lever counterclockwise to the dump position (by-pass flow). Failure to follow this will void the warranty on the pump.

Turn the adjustment knob counterclockwise to decrease the pressure to zero ("0") psi. In the initial start-up, this is absolutely recommended.

When the valve is in the by-pass line, start the unit and let it run for at least two (2) minutes or until oil is displaced in the cylinder and air is evacuated from circuit.

Turn the valve lever clockwise to pressure position, close the spray gun or spray boom. Turn the adjustment knob clockwise to achieve operating pressure. Then open the spray gun or spray boom.

## CHEMICAL RESISTANCE CHART

The recommendations in the chart below are based upon information from material suppliers and careful examination of available published information and are believed to be accurate. The resistance of metals, plastics and elastomers may be affected by concentration, temperature, presence of other chemicals and other factors. This information should be considered as a general guide rather than an unqualified guarantee. All recommendations assume ambient temperatures unless otherwise noted. The ratings for these materials are based upon the chemical resistance only.

Material	Viton	Buna N (Nitrile)	Material	Viton	Buna N (Nitrile)	Material	Viton	Buna N (Nitrile)
Acetaldehyde	A	B	Acetone	D	D	Ethyl	A	A
Acetamide	A	A	Acetylene <sup>2</sup>	A	A	Hezyl	A	A
Acetate Solv <sup>2</sup>	D	D	Acrylonitrile	C	D	Isobutyl	A	C
Acetic Acid, Glacial <sup>1</sup>	D	D	Alcohols Amyl	A	A	Isopropyl	A	C
Acetic Acid 20%	D	C	Benzyl	A	D	Methyl	C	B
Acetic Acid 80%	D	C	Butyl	A	A	Octyl	A	B
Acetic Acid	C	C	Diacelone <sup>2</sup>	D	D	Propyl	A	A
Acetic Anhydride	D	A						

A = Acceptable, No effect  
 B = Acceptable, Minor effect

C = Questionable, Moderate effect  
 D = Not Recommended, Severe effect

# DP 407.1

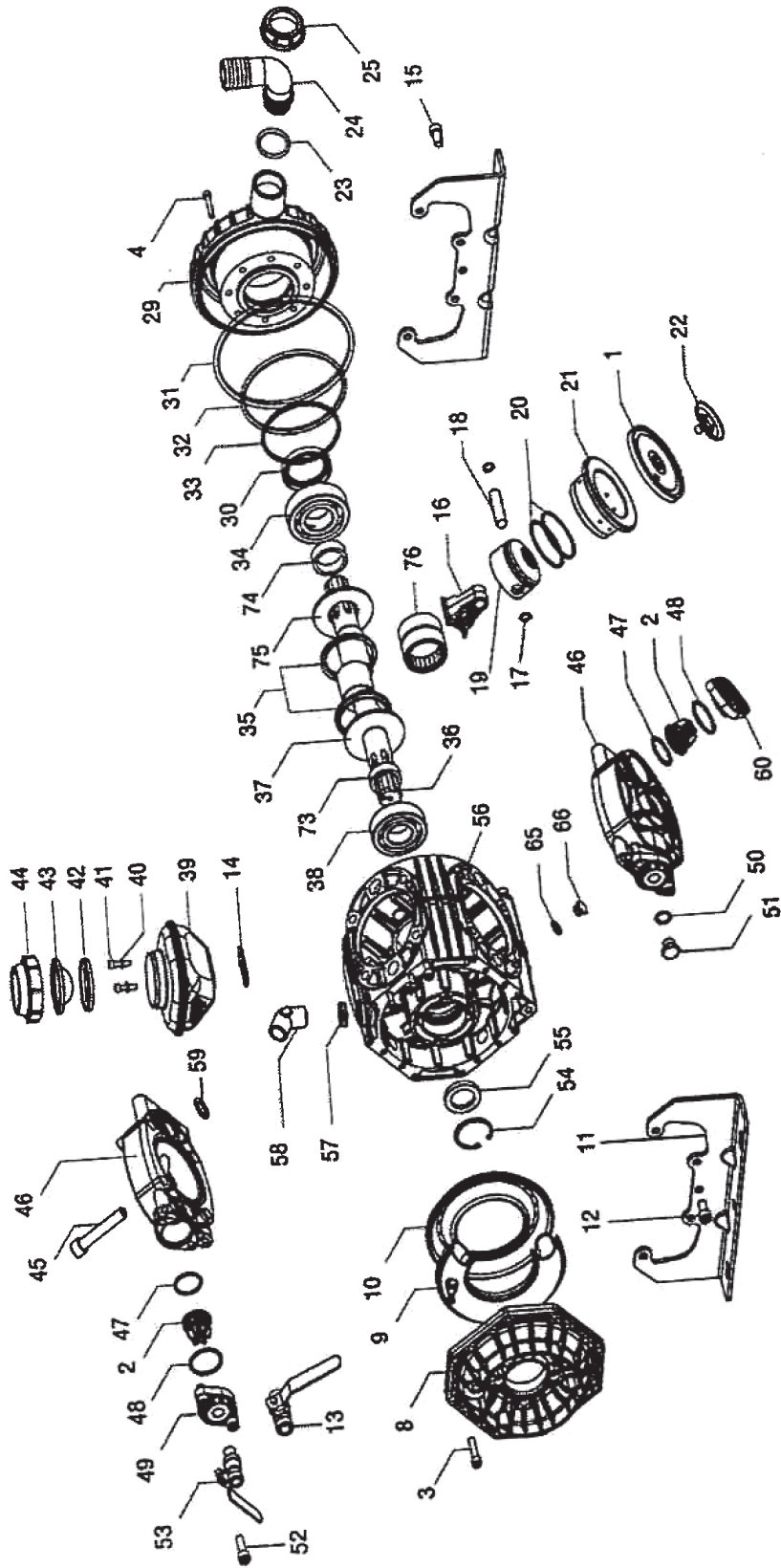

# DIAPHRAGM PUMP MODEL DP-407.1 PARTS LIST

❖ Pump Repair Kit Order DP-41990597

Valve Kit Order DP-41987097

ITEM	PART NUMBER	DESCRIPTION	QTY	ITEM	PART NUMBER	DESCRIPTION	DP-407
1 ❖	DP-95004031	BUNA-N PISTON DIAPHRAGM	4	33 ❖	DP-80329100	O-RING, DIA. 3.53X88,5	1
1	DP-95004033	VITON PISTON DIAPHRAGM (OPT)	4	34	DP-81291300	BALL BEARING 6308 "VD"	1
1	DP-95004000	DESMOPAN PISTON DIAPHRAGM (OPT)	4	35	DP-14001576	CONROD HOLDING RING	2
1	DP-95004036	HPS PISTON DIAPHRAGM (OPT)	4	36	DP-41015026	CRANKSHAFT "VD"	1
2 <input type="checkbox"/>	DP-35980297	VALVE ASSEMBLY	8	37	DP-41015361	SHAFT RING	1
3	DP-86273000	SCREW M8X30	20	38	DP-81287000	ROLLER BEARING	1
4	DP-86275200	SCREW M8X35	8	39	DP-40980197	OIL FILLER ASSY	1
5	DP-31146632	PLAIN SAFETY CONE (OPT)	1	40	DP-84358500	WASHER	1
6	DP-86184600	SCREW M5, 5X16 (OPT)	3	41	DP-86221600	BOLT, M6X25	2
7	DP-84356000	WASHER DIA. 5,5X15X1,6 (OPT)	3	42	DP-14011632	DIAPHRAGM SPACER	1
8	DP-41010509	BALLASTER COVER	1	43 ❖	DP-41001731	OIL FILLER DIAPHRAGM	1
9 ❖	DP-41012097	NBR BALLASTER DIAPHRAGM	1	44	DP-28014432	OIL FILLER COVER	1
10	DP-41010409	LOWER BALLASTER	1	45	DP-86425000	SCREW, M14X70	16
11	DP-41011361	MOUNTAINING RAIL	2	46	DP-41011109	PUMP HEAD	4
12	DP-86326500	SCREW M10X25	5	47 ❖ <input type="checkbox"/>	DP-80325100	O-RING, DIA. 3,53X32,93	8
13	DP-84554410	LEFT TAP G.3/8-G.1/2	1	48 ❖ <input type="checkbox"/>	DP-80326200	O-RING DIA. 3,53X41,28	8
14 ❖	DP-14001772	GASKET	1	49	DP-41011009	VALVE COVER, G. 3/8"	4
15	DP-86326500	SCREW M10X25	5	50 ❖	DP-82410700	GASKET	2
16	DP-41016509	CONROD	4	51	DP-85257900	CAP, G. 3/8"	2
17	DP-80002100	RING DIA. 15	8	52	DP-86330000	SCREW, M10X30	16
18	DP-85200700	PISTON PIN, DIA. 15X24	4	53	DP-84554400	RIGHT TAP, G. 3/8" – G. 1/2"	1
19	DP-37001609	PISTON	4	54	DP-80136900	SNAP RING, DIA. 52	1
20	DP-81852700	PISTON RING	8	55 ❖	DP-80214310	OIL SEAL, DIA. 35X52X7	1
21	DP-43001501	PISTON SLEEVE	4	56	DP-41013309	CRANKCASE	1
22	DP-41983597	KIT DISK + SCREW INOX	4	57	DP-81490900	BRASS NUT	1
23 ❖	DP-80321910	O-RING, DIA. 3.0X30	1	58	DP-83506328	60 DEGREE ELBOW CONN.	1
24	DP-84059100	90 DEGREE ELBOW CONN.	1	59 ❖	DP-80320000	O-RING, DIA. 2,62X22,22	8
25	DP-82007000	WING NUT, G. 1-1/2"	1	60	DP-41010909	VALVE COVER	4
29	DP-41011209	INLET COVER "VD"	1	65	DP-82407900	WASHER	1
30 ❖	DP-80219000	OIL SEAL, DIA. 40X72X10 "VD"	1	66	DP-85254350	CAP G.1/4"	1
31 ❖	DP-80329500	O-RING, DIA. 3,53X190,10	1	73	DP-41015676	SHAFT SPACER DIA. 35MM	1
32 ❖	DP-80321070	O-RING, DIA. 2,62X126,67	1	76	DP-81295000	NEEDLE ROLLER BEARING	2



**CDS-JOHN BLUE COMPANY**

DIVISION OF ADVANCED SYSTEMS TECHNOLOGY, INC.

165 Electronics Blvd., Huntsville, Alabama 35824

Telephone: (256) 721-9090 • FAX (256) 721-9091 • Call Toll Free: 1-800-253-2583

<b>TROUBLES AND CURES</b>		
<b>TROUBLES</b>	<b>CAUSES</b>	<b>CURES</b>
The pump doesn't reach the required pressure	<ul style="list-style-type: none"> <li>• valves have worn seats</li> <li>• suction hose with air pockets or irregular elbows</li> <li>• worn nozzles or with wrong diameter (see chart)</li> <li>• Clogged strainer</li> </ul>	<ul style="list-style-type: none"> <li>• check valves</li> <li>• check hoses</li>   <li>• check nozzles</li> <li>• clean strainer</li> </ul>
The pressure gauge fluctuates	<ul style="list-style-type: none"> <li>• pump is sucking air, or air hasn't been evacuated completely</li> <li>• valves blocked</li> </ul>	<ul style="list-style-type: none"> <li>• start pump with the gun open, to evacuate the air and commutate</li> <li>• clean and change valves</li> </ul>
The liquid flow is irregular	<ul style="list-style-type: none"> <li>• the air in the pulsation-damper is incorrectly set</li> </ul>	<ul style="list-style-type: none"> <li>• check pressure in pulsation damper (see chart)</li> </ul>
Output drops and the pump is noisy	<ul style="list-style-type: none"> <li>• oil level is too low</li> </ul>	<ul style="list-style-type: none"> <li>• top up with oil to correct level (halfway of the sump), when pump is operating</li> </ul>
Oil comes out of the discharge pipe	<ul style="list-style-type: none"> <li>• one or more diaphragms are broken</li> </ul>	<ul style="list-style-type: none"> <li>• Drain the pump of oil. Dismantle the head and change diaphragms. Fill to the correct oil level.</li> </ul>
Oil is changing color into white	<ul style="list-style-type: none"> <li>• Diaphragms failures. Stop pump immediately.</li> </ul>	<ul style="list-style-type: none"> <li>• Drain the pump of oil. Dismantle the head and change diaphragms. Fill to the correct oil level.</li> </ul>

## LIMITED WARRANTY

THIS WARRANTY IS IN LIEU OF ALL OTHER WRITTEN OR EXPRESS WARRANTIES AND REPRESENTATIONS. ANY IMPLIED WARRANTIES INCLUDING MERCHANTABILITY OR FITNESS FOR ANY PARTICULAR PURPOSE ARE EXPRESSLY LIMITED TO THIS WRITTEN WARRANTY. CDS-JOHN BLUE COMPANY SHALL NOT BE LIABLE FOR CONSEQUENTIAL DAMAGES.

Use of this product for any purpose other than its original intent, abuse of the product, and/or any modification to the original product is strictly prohibited by the manufacturer, CDS-John Blue Company. Any modification to the product should be approved by CDS-John Blue Company prior to use. CDS-John Blue Company will deny Warranty claims and liability in any situation involving misuse, abuse or modification.

Each new machine or component manufactured by CDS-John Blue Company through original buyer is warranted by CDS-John Blue Company to buyer and to any party or parties to whom buyer may resell, lease or lend the equipment to be free from defects in material and workmanship under normal use and service. This obligation of CDS-John Blue Company under this warranty is limited to the repair or replacement of defective parts or correction of improper workmanship of any parts of such equipment which shall within one year from the date of CDS-John Blue's original delivery thereof, be returned to CDS-John Blue's factory, transportation charges prepaid and which CDS-John Blue Company shall determine to its satisfaction upon examination thereof to have been thus defective. When it is impractical to return the defective parts of such equipment to CDS-John Blue's factory, then CDS-John Blue shall have no liability for the labor cost involved in repairing or replacing any such parts and shall be liable solely for supplying the material necessary to replace or repair the defective parts, provided that prior thereto CDS-John Blue Company shall have determined to its satisfaction that any such parts are thus defective.

This warranty shall not apply to any equipment which shall have been repaired or altered outside CDS-John Blue's factory in any way so as to affect its durability, nor which has been subjected to misuse, abuse, negligence or accident, or operated in any manner other than in accordance with operating instructions provided by CDS-John Blue Company. This warranty does not extend to repairs made necessary by the use of inferior or unsuitable parts or accessories, or parts or accessories not recommended by CDS-John Blue Company.

CDS-John Blue Company makes no warranties in respect to parts, accessories or components not manufactured by CDS-John Blue Company, same ordinarily being warranted separately by their respective manufacturers.

DIVISION OF ADVANCED SYSTEMS TECHNOLOGIES

HUNTSVILLE, AL

(256) 721-9090